

Guide to Slots with Moving Discs

Fig.1

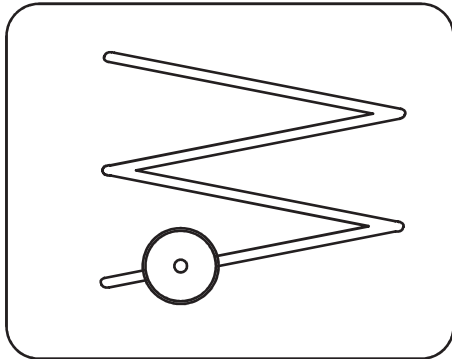
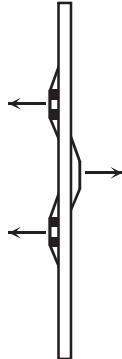

Fig.2



When designing slot panels, it is a good idea to think about expansion rates, the stresses and strains that may be put on the panel by the way you are inevitably going to fix it to your structure.

If you look at Fig.1 on the left, you will see that there are 3x V-Shaped fingers, which because of the slots are unsupported along their length, while the rest of the panel may or may not be controlled by your framework. These fingers are free to move in any direction. In this instance we would expect these fingers to move in different directions to the main panel (see Fig.2) and therefore make sliding a disc difficult or impossible.

If you follow the guidelines we have put together here, you should have little or no problems with your final product design.

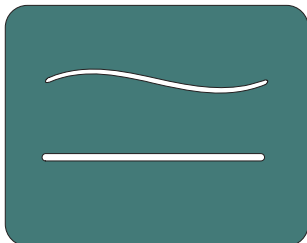

Straight or slight curves

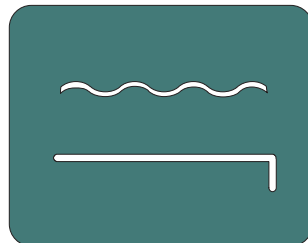

Shallow wave and short returns

OK

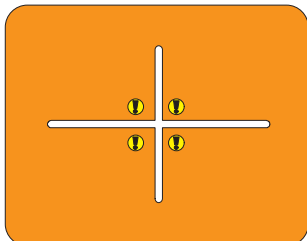

Intersecting lines or curves

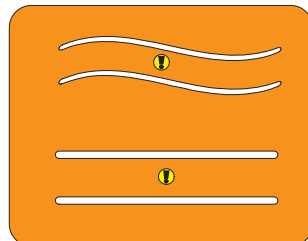

Parallel lines or curves closely spaced

With
CAUTION

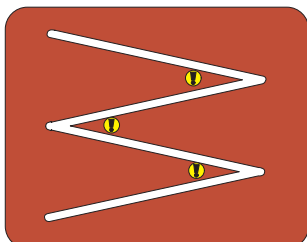

Long and tight angled curves or lines

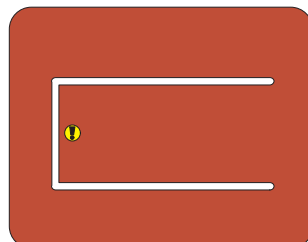

Large unsupported sections

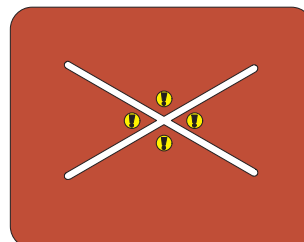

Long intersecting lines or curves with tight angles

NOT
GOOD

Don't forget, if you would like us to look at your idea and give you advice, then please call our office