

Product Information

FISENFID - Sensory Fidget Play Panel

BS EN 1176 - Designed to British & European Standards







MATERIALS

Panel - Two Colour  High Density Polyethylene (HDPE)

SUPPLY METHOD

Panel - Singular panel

FEATURES

-  **INCLUSIVE** - Activity positioned at accessible height
-  **SLIDERS** - Various counters along a curve
-  **ROLLERBALL** - Pink and blue roller balls
-  **ROTATE** - Shape spinners & moulded ball spinner
-  **FLIP** - Create a simple pattern using the two colour rollers
-  **TOUCH** - Finger trace maze



DIMENSIONS

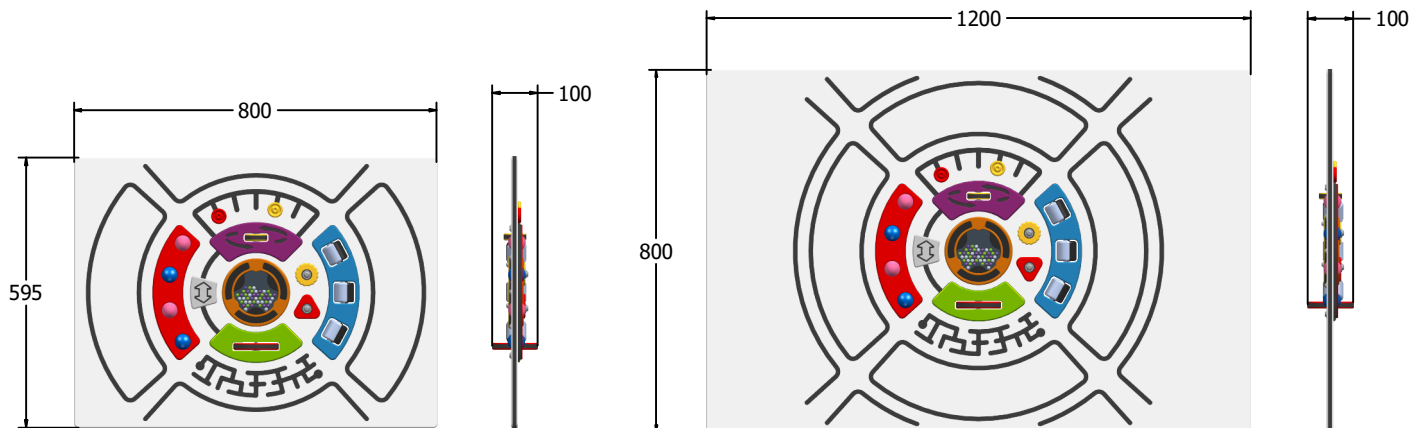

FISENFID6 Standard Panel
FISENFID6-AL-WP Panel with Alu Posts

FISENFID3 Standard Panel
FISENFID3-AL-WP Panel with Alu Posts

TECHNICAL

Age Range: 2+ Years
Largest Part: FISENFID6 - 595 x 800 x 100mm
Total Weight: FISENFID6 - 7.6kg
Surfacing: N/A

Age Range: 2+ Years
Largest Part: FISENFID3 - 800 x 1200 x 100mm
Total Weight: FISENFID3 - 14.4kg
Surfacing: N/A

IMPORTANT: you must specify the colour option you require at the time of order if it is different from the colour listed/shown above, requirements are subject to availability at the time of order